

HO Scale 1:87  
**2019**  
 GAS N' GO

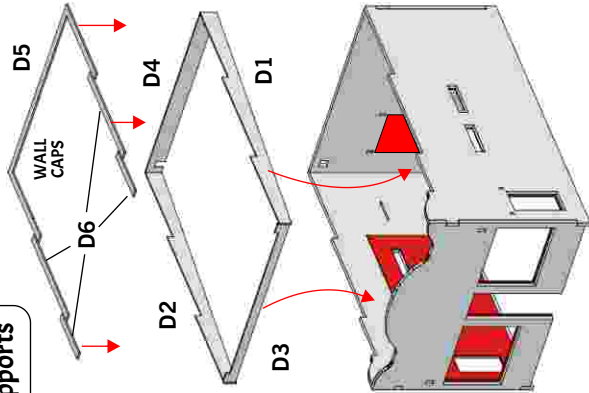

We recommend that you read through the entire instructions and test fit all parts before applying glue.

**STEP 3** Roof Supports



**STEP 1** Main Wall Assembly

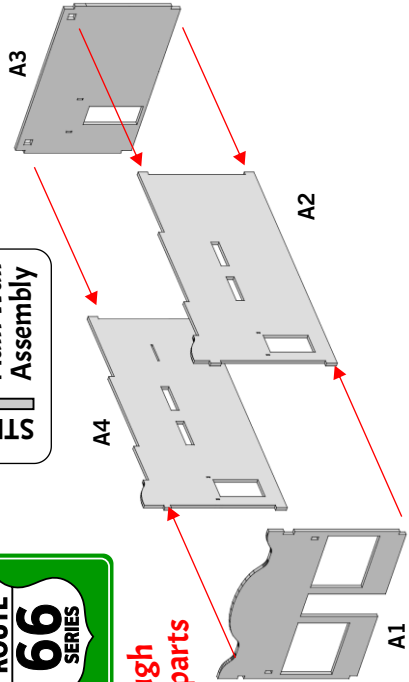

**STEP 2** Interior Walls

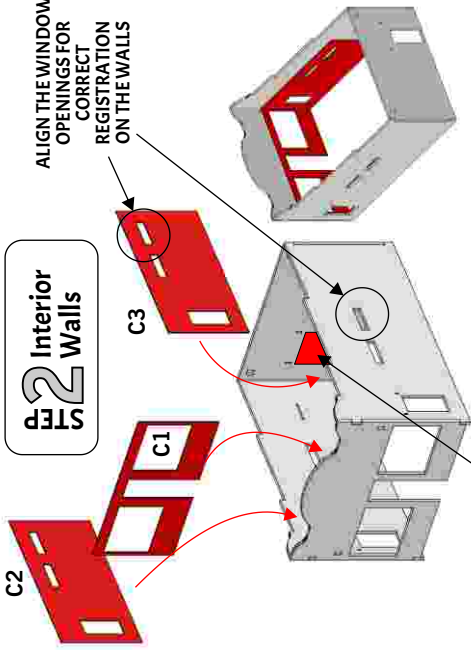

**STEP 4** Roof

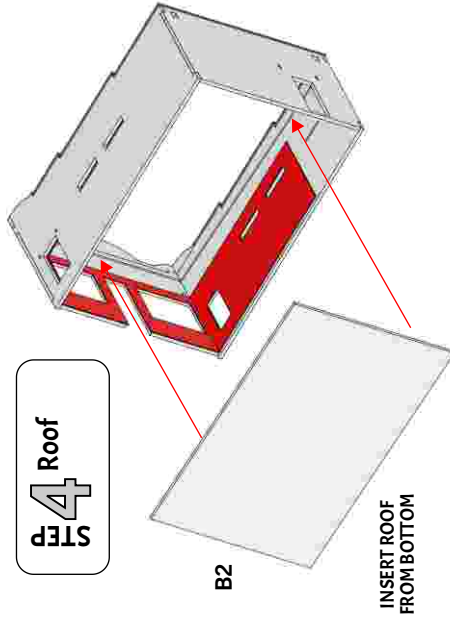

**STEP 6** Interior

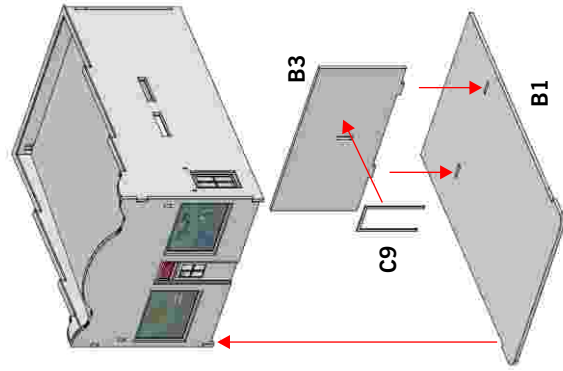

WEATHERHEAD

.020" OR .025" BRASS WIRE OR STYRENEROD (NOT INCLUDED)



METER BASE

**STEP 5** Storefront

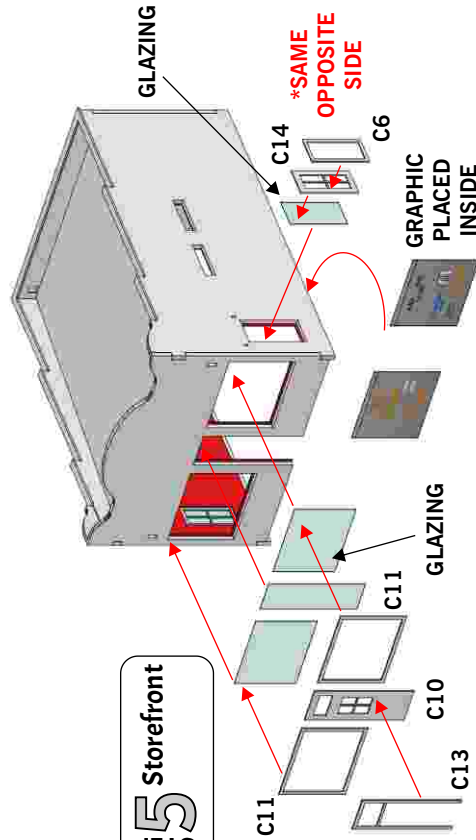

**SHOWCASE**  
 Miniatures

**STEP 7**  
Front Canopy

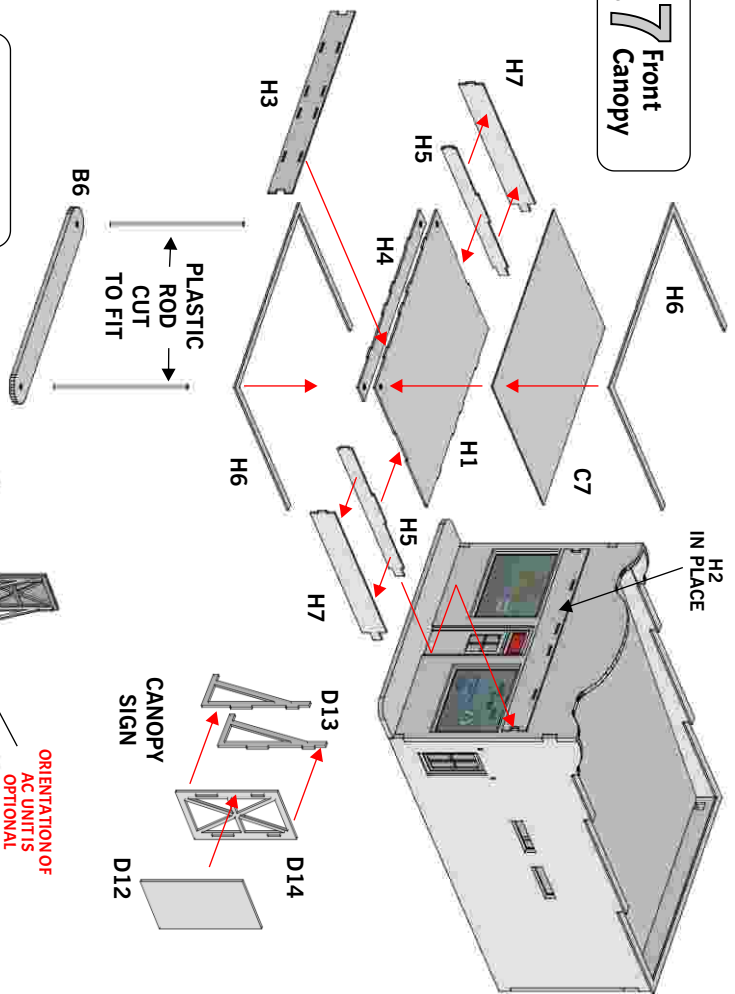

**STEP 9**  
Rear Shed

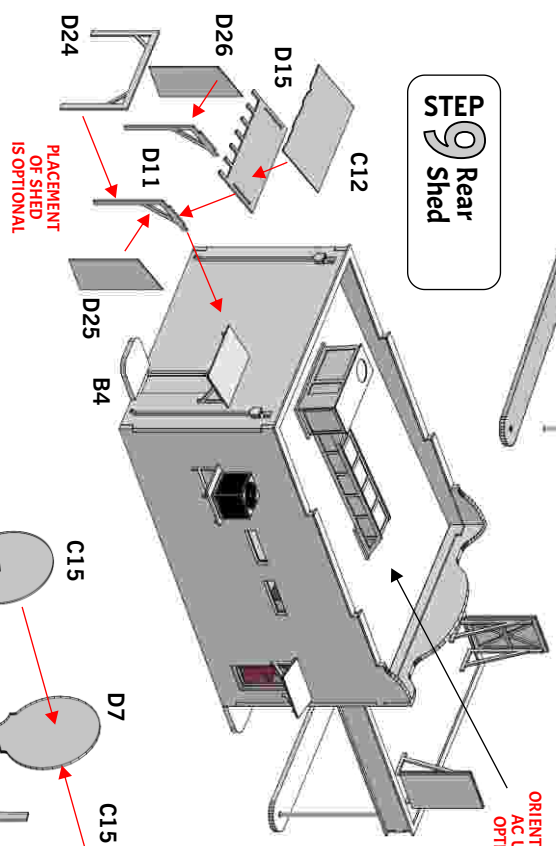

**STEP 8**  
Rear Details

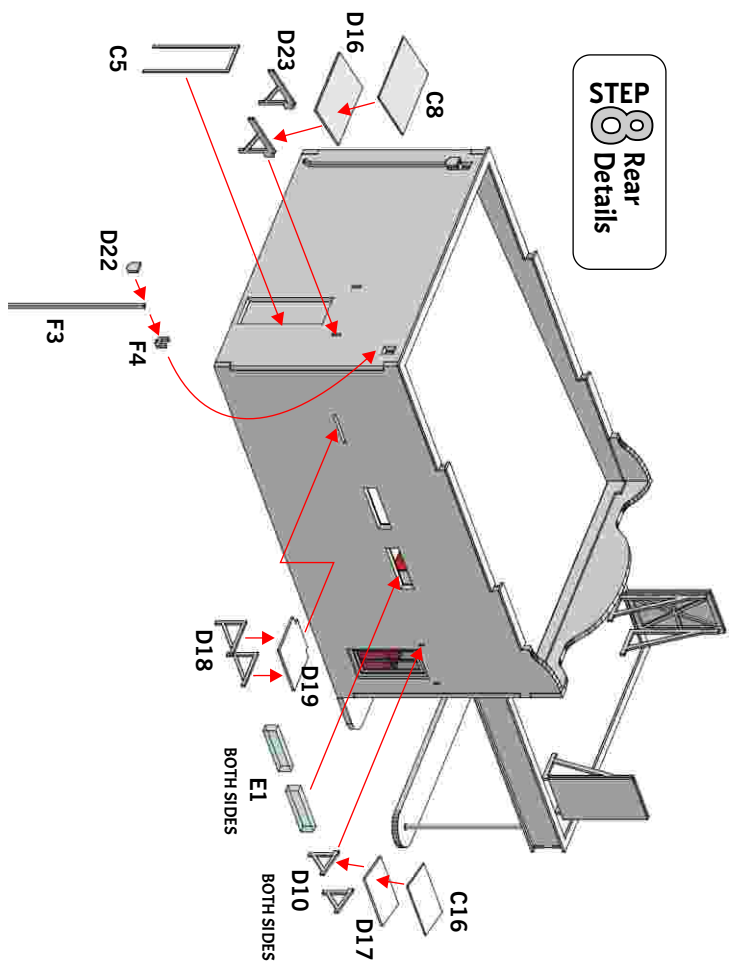

**STEP 10**  
Roof Details

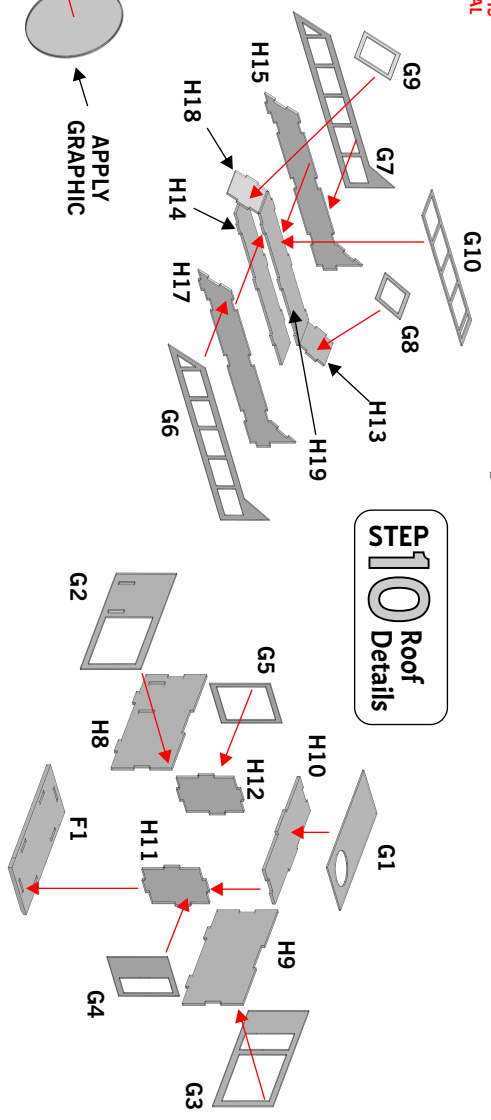

**STEP 11**  
Front Signs

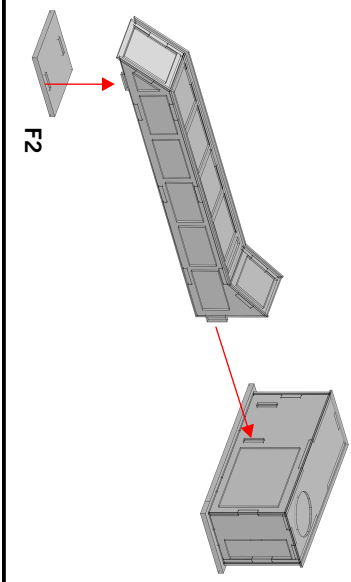
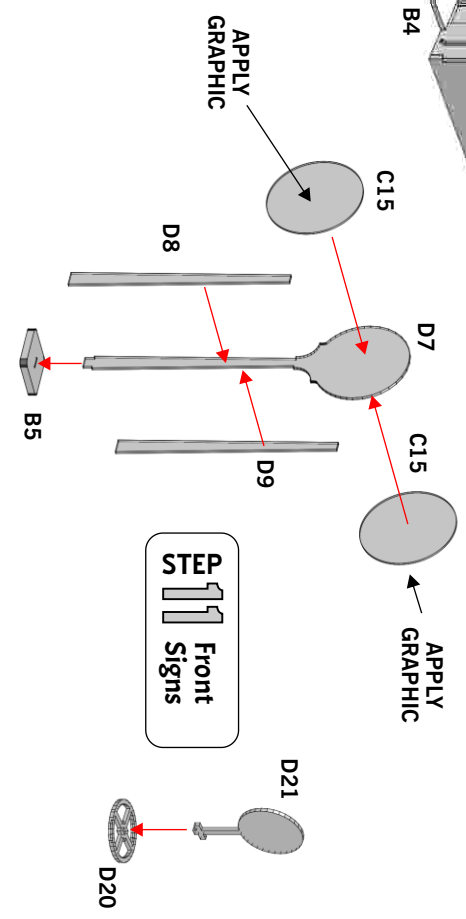

# -PARTS LIST-

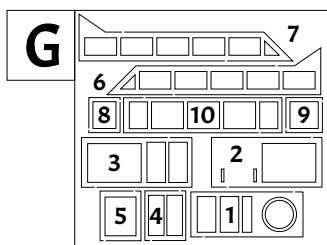
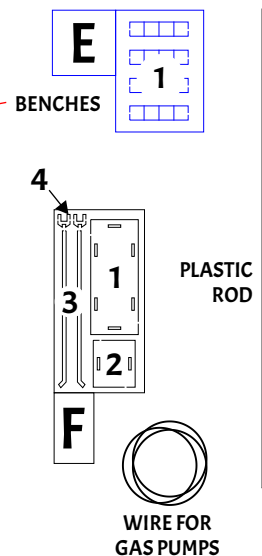
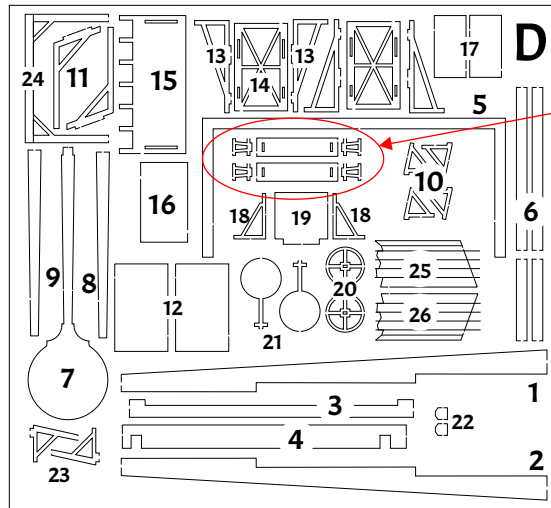
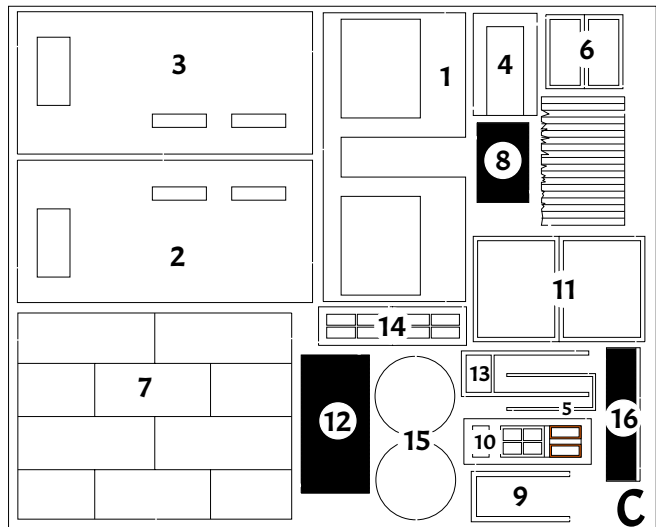
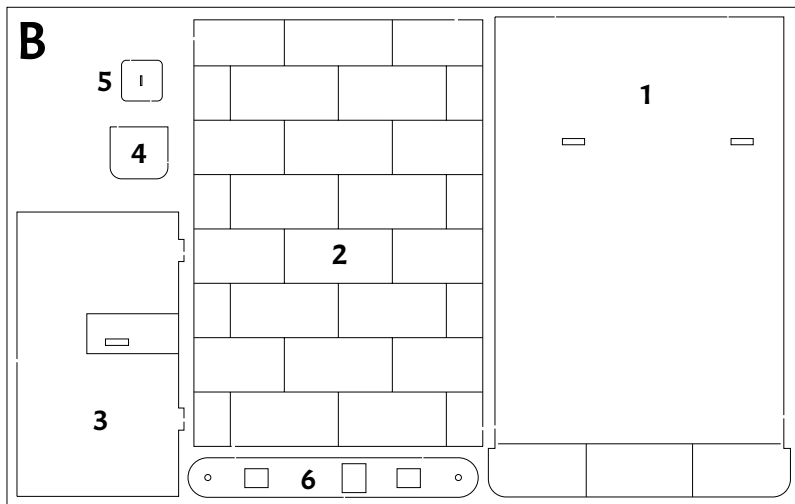
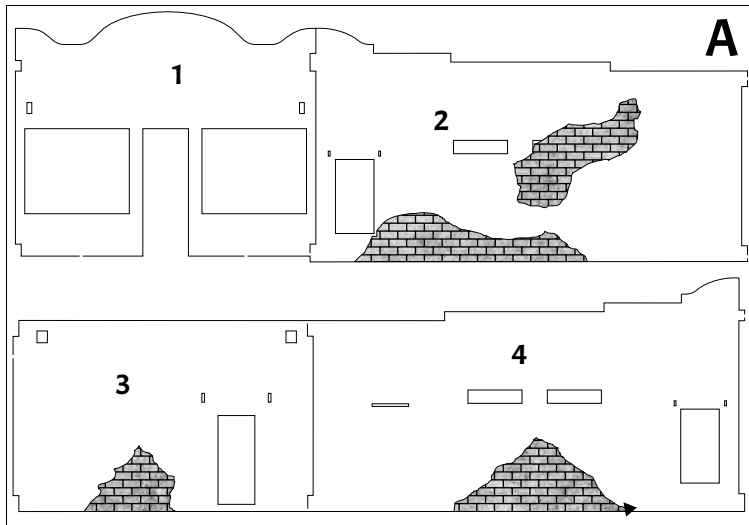

WATERSLIDE DECALS

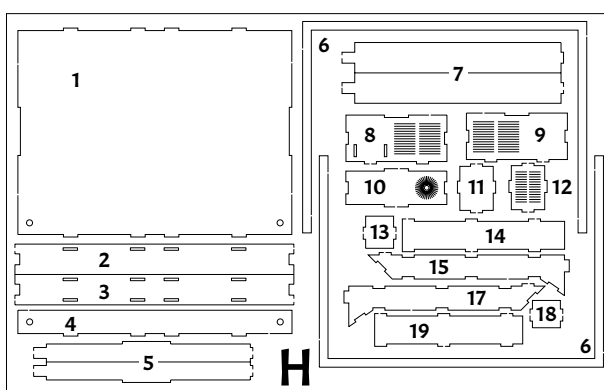

GLAZING

## RESIN AND PEWTER PARTS:

- GAS PUMPS
- OIL RACK
- TRASH CANS
- NEWSPAPER STAND
- METER BASE AND WEATHER HEAD
- SODA MACHINE
- ICE COOLER
- AC EVAPORATIVE COOLER UNIT

HI RESOLUTION GRAPHICS

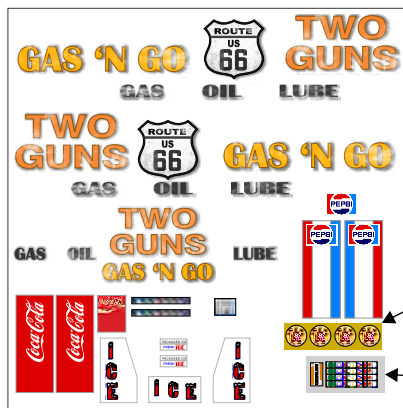

PUMP GLOBES

OIL RACK



MAIN SIGN

GAS PUMP

SMALL SIGN

We recommend that you read through the entire instructions and test fit all parts before applying glue.

## **- PAINTING AND DECALS -**

USE A SOLVENT BASED PRIMER ON THE WALLS, THEN, EITHER ACRYLIC OR ENAMEL PAINTS CAN BE USED AND ADHERE WELL TO THE WALL BOARD. A GOOD, SMOOTH COAT OF BASE PAINT IS REQUIRED FOR THE WATERSLIDE DECALS.

CLEAN METAL AND RESIN PARTS WITH SOAPY WATER.

THE KIT CONTAINS WATERSLIDE GRAPHIC SIGNAGE THAT CAN EITHER BE CUT OUT AND GLUED ON THE SIGN PLACARDS USING CA TYPE SUPER GLUE OR USED AS WATERSLIDE DECALS. REFER TO THE PHOTOS OF THE FINISHED MODEL FOR PLACEMENT.

FOR BEST RESULTS, CUT THE DECALS OUT CLOSE TO THE GRAPHIC AND ALLOW THEM TO FLOAT ON THE WATER FOR A MINUTE OR SO - NOT TOO LONG. IF POSSIBLE, DO NOT ALLOW THE DECAL TO BE SUBMERGED COMPLETELY.

THE SODA MACHINE, PUMP GLOBES, OIL RACK AND THE ICE BIN MUST BE PAINTED WHITE ON THE SIDES WHERE THE WATERSLIDE DECAL WILL BE APPLIED.

## **Paint Colors for Two Guns (Vallejo Paint Colors)**

### **Building Body Colors:**

- 10x Dead White 72.001
- 1x Old Wood 310
- 1x Cork Brown 70.843

### **Building Trim, Sign Posts, and Bracket Colors:**

- 10x Bright Orange 70.851
- Sky Gray 70.989
- Cold Gray 72.050

### **Building Brick Colors:**

- Flat Brown 70.984 (base color)
- Beige Brown 70.875
- Cork Brown 70.843
- Sky Gray 70.989 (water diluted wash)

### **Rooftop and Driveway**

- See article titled "Spraying a Mist with a Swipe of the Wrist" in the Trackside Talk" section of Showcase Miniatures' website for colors and application information.